



Features

- Electrical interface compliant to SFF-8431
- Hot Pluggable
- 850nm VSCSEL transmitter, PIN photo-detector receiver
- Up to 300m on OM3 MMF
- Operating case temperature 0~70°C
- All-metal housing for superior EMI performance
- RoHS Compliant (lead free)

Applications

- 10 Gigabit Ethernet
- 4G and 8G Fibre Channel Applications
- 1x InfiniBand QDR, DDR, SDR
- High-performance computing clusters
- Servers, switches, storage and host card adapters

SFP+ AOC Specifications

<i>Parameter</i>	<i>Description</i>
Module Form Factor	SFP+ (Supports SFF8431/SFF8432/SFF8472)
Protocols Supported	InfiniBand, Ethernet, Fiber Channel
Channel Data Rate	Rate 1 to 10.3125Gbps
BER	<10 ⁻¹²
Operating Case Temperature	0 to + 70°C
Storage Temperature	-20 to + 85°C
Supply Voltage	3.3V
Supply current	230mA per end typical
Management Interface Serial	I ² C (Supports SFF8472)

Optical Characteristics-Transmitter

<i>Parameter</i>	<i>Symbol</i>	<i>Min</i>	<i>Typ</i>	<i>Max</i>	<i>Units</i>	<i>Notes</i>
Center Wavelength	λ_t	840	850	860	nm	
RMS spectral width	Pm	-	-	Note 1	nm	
Average Optical Power	Pavg	-6.5	-	-1	dBm	Note 2
Extinction Ratio	ER	3.5	-	-	dB	Note 3
Transmitter Dispersion Penalty	TDP	-	-	3.9	dB	
Relative Intensity Noise	Rin	-	-	-128	dB/ Hz	12dB reflection
Optical Return Loss Tolerance		-	-	12	dB	

Note:

1. Trade-offs are available between spectral width, center wavelength and minimum OMA
2. The Optical power is launched into MMF
3. Measured with a PRBS $2^{31}-1$ test pattern @10.3125Gbps,

Optical Characteristics – Receiver

<i>Parameter</i>	<i>Symbol</i>	<i>Min</i>	<i>Typ</i>	<i>Max</i>	<i>Units</i>	<i>Notes</i>
Center Wavelength	λ_r	840	850	860	nm	
Receiver Sensitivity	Psens	-	-	-11.1	dBm	Note 1
Stressed Sensitivity in OMA		-	-	-7.5	dBm	Note 1
Los function	Los	-30	-	-12	dBm	
Overload	Pin	-	-	-1.0	dBm	Note 1
Receiver Reflectance		-	-	-12	dB	

Notes: **1. Measured with a PRBS $2^{31}-1$ test pattern @10.3125Gbps, $BER \leq 10^{-12}$**

Dimensions

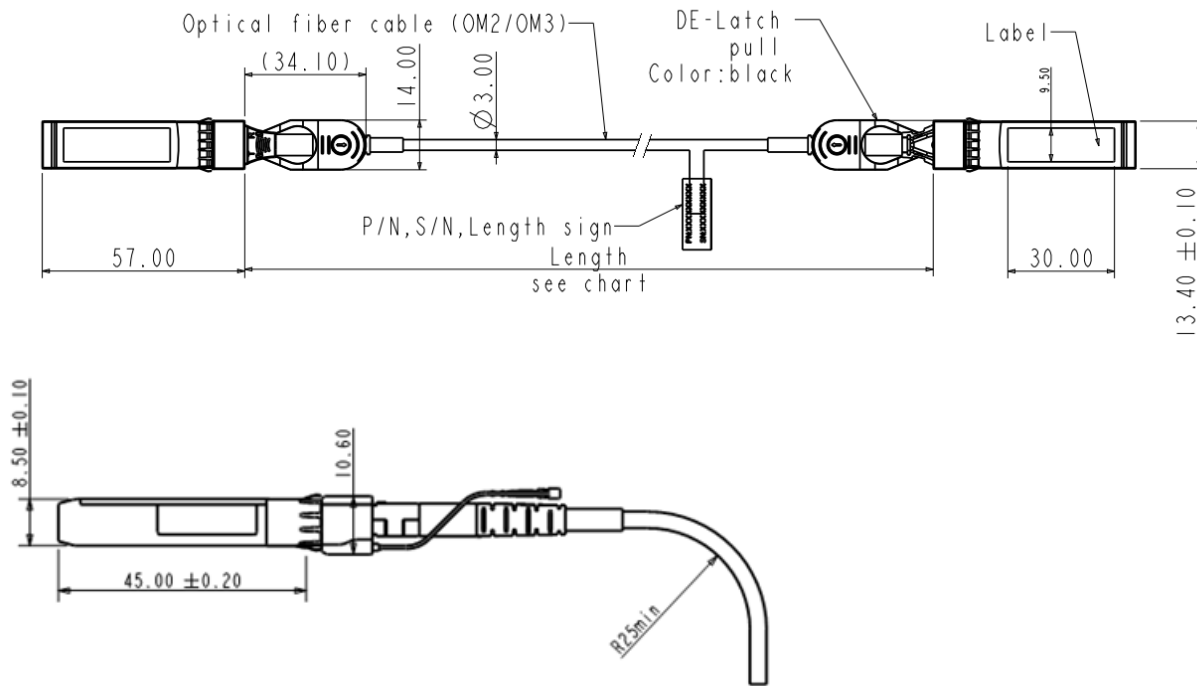

Ordering Information



AOC-OM3-SFP-xM

Cable Length:
X5=0.5M ; 1M=1M;

Part Number	Model Number	Length (M)	Voltage	Temperature
AOC-OM3-SFP-3M	Active Optical Cable	3	3.3V	0°C ~ 70°C

Note: All information contained in this document is subject to change without notice.

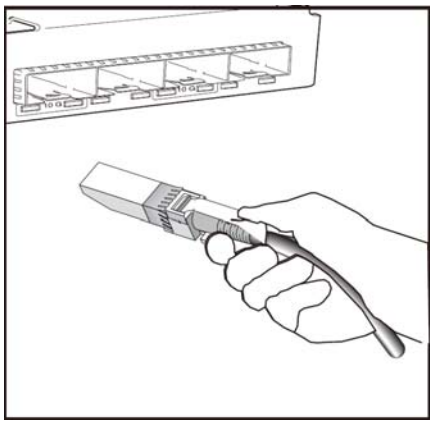
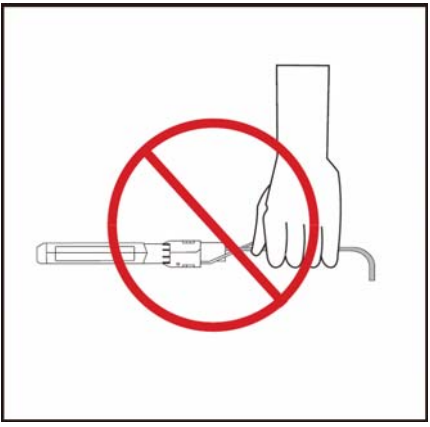
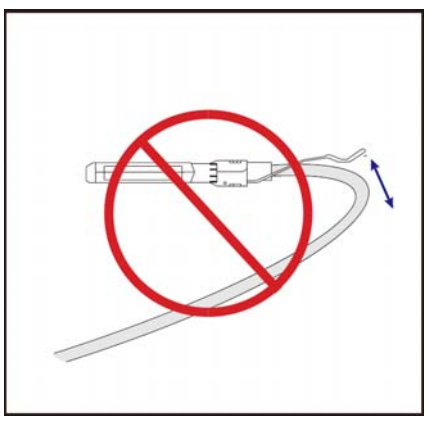
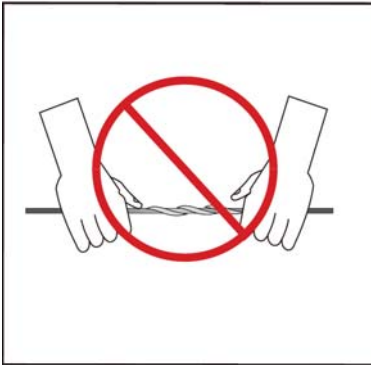
Important Notice

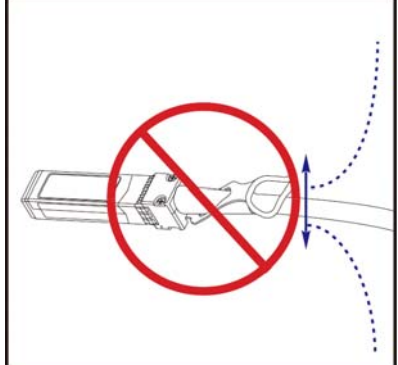
		
<p>Holding the SFP+ connector by its sides, insert the connector into the port on the switch</p>	<p>Do not handle by cable</p>	<p>DO NOT Over-bend the cable behind the connector</p>
		
<p>DO NOT twist the cable</p>	<p>DO NOT kink the cable</p>	<p>DO NOT bend up and down the cable</p>